

Easter Egg

72 x 72 x 100 mm

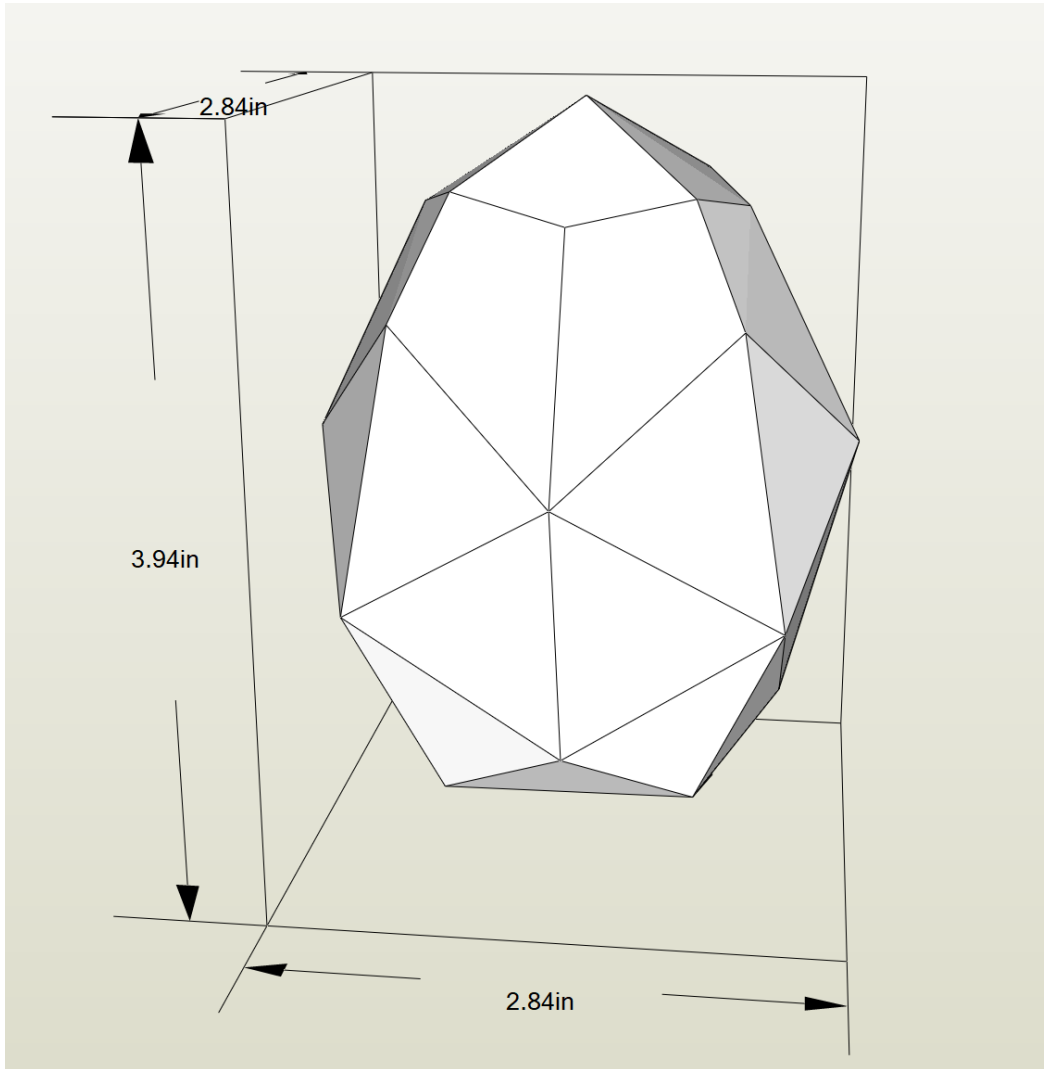

- Difficulty level: ★☆☆☆☆ (1/5) Easy
- Assembling time: 2 - 5 hours
- Parts: 1

Suggested Colors:

- Color your egg however you want and make your own unique creative decorative egg. You can use pencil crayons, markers, or pastels.
- Or you can print your egg on a colored cardstock paper

After coloring your egg, you can cut, fold, and glue it to a beautiful easter egg

PaperProject3D. This file is protected by copyright and should not be distributed in any way.

Instructions

1



Size: Letter
64-110lb

Get Required white and colored paper
Print Templates

Alternative paper:
A4 Card Stock (100-300gsm)
Apply "Fit to page" settings when printing

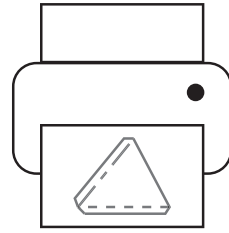

2

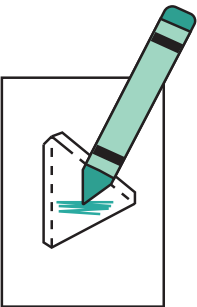

Color using pencil, marker,
or pastel crayons
OR
Print on desired color paper

3

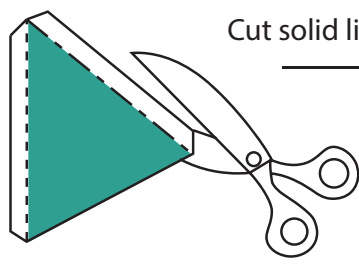

Cut solid lines

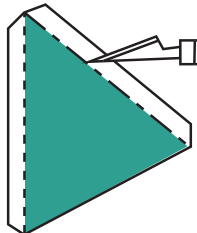
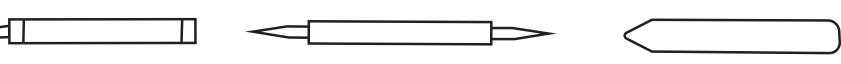

4

Gently score dotted and dash dotted lines for easy folding
using back of a knife, embossing stylus, or bone folder

- - - - -

5

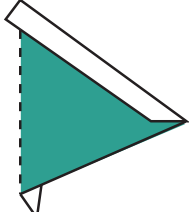



Fold dashdotted lines to valley folds

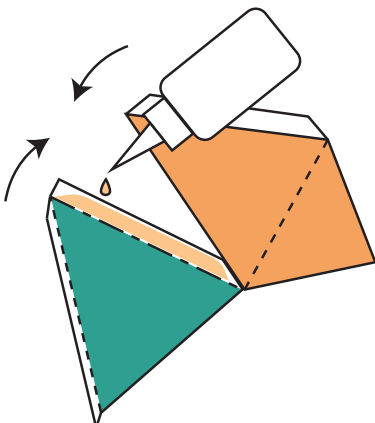
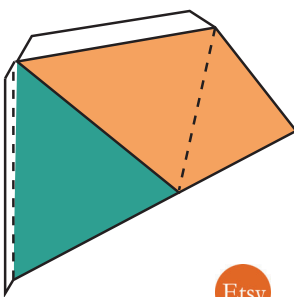

Fold dotted lines to mountain folds

6

Glue adjacent tabs. Tabs go
on the colorless side or the
interior of the model